

aksa
JENERATÖR

aksa POWER
GENERATION

DİZEL MOTOR JENERATÖR
GRUBU MONTAJ, ÇALIŞTIRMA,
KULLANMA ve BAKIM EL KİTABI

DIESEL GENERATING SETS
INSTALLATION RECOMENDATIONS
and OPERATIONS MANUAL

AAP 4200 DE

AKSA POWER DIESEL

AKSA GENERATOR
AKSA POWER PORTABLE SERIES USER MANUAL
PLEASE READ THIS MANUAL CAREFULLY; IT CONTAINS IMPORTANT SAFETY INFORMATION

DİZEL JENERATÖR / DIESEL GENERATOR

AAP 4200 DE



İTHALATÇI FİRMA / IMPORTER COMPANY

AKSA JENERATÖR SAN.A.Ş.

Gülbahar Caddesi 1. Sokak 34212 No:2

Güneşli / İstanbul

T: + 90 212 478 66 66

F: + 90 212 657 55 16

e-mail: marketing@aksa.com.tr

ÜRETİCİ FİRMA / MANUFACTURER COMPANY

CHANGHOU CHANGFA IMP. EP.CO.LTD.

**Adres: Changfa Industrial Park,
South of Changzhou, Jiangsu, China**

Tel: +86-519-6237006

e-mail: sales@changfa.com

YETKİLİ SERVİS / AUTHORIZED SERVICE

AKSA SERVICE & SPARE PARTS

Adres/Adress: Murat Bey Beldesi

Güney Girişi Cad. No:8

34540 Çatalca / İstanbul

T: + 90 212 887 11 11

F: + 90 212 887 10 20

e-mail: info@aksaservis.com.tr

ABOUT WARRANTY

Aksa Power Generation will repair or replace, free of charge, any part(s) of the equipment that is defective in material or workmanship or both. Transportation charges on product submitted for repair or replacement under this warranty must be borne by purchaser. This warranty is effective for the time periods and subject to the conditions stated below. For warranty service, find the nearest Authorized

Service Dealer

DEAR AKSA GENERATING SET OPERATOR,

PLEASE TAKE CARE TO THE FOLLOWING ORDER TO PREVENT THE GENERATING SET WARRANTY TO BECOME INVALID BEFORE THE TERMINATION OF THE WARRANTY PERIOD AND TO ENSURE TROUBLE-FREE OPERATION OF THE GENERATING SET WITH A LONG LIFE!

- MAINTENANCE AND REPAIR WORKS WILL NOT BE COVERED BY THE WARRANTY CERTIFICATE, INVOICE OR DELIVERY CERTIFICATE OF THE GENERATING SET IS SUBMITTED.
- THE WARRANTY OF THE GENERATING SET WILL BECOME INVALID IN CASE OF ANY INTERVENTION OF ANY PERSON OTHER THAN AUTHORIZED AKSA SERVICES OR BY PRIOR WRITTEN APPROVAL FROM AKSA POWER GENERATION ON THE GENERATING SET FOR ANY REASON.
- CONTROL AND MAINTENANCE WORKS INDICATED IN THE PERIODICAL MAINTENANCE SCHEDULE AND THE OPERATING MANUAL MUST BE CARRIED OUT COMPLETELY AND TIMELY. THE FAILURES DUE TO INCOMPLETE OR UNTIMELY MAINTENANCE ARE NOT COVERED BY THE WARRANTY.
- GENERATING SET SHOULD BE MOUNTED AS INDICATED IN THE OPERATING MANUAL. OTHERWISE, THE PROBLEMS WHICH ARE LIKELY TO OCCUR WILL NOT BE COVERED BY THE WARRANTY. CUSTOMER IS RESPONSIBLE FOR THE FAILURES WHICH ARE LIKELY TO OCCUR IN CASE THAT THE DIESEL OIL USED CONTAINS DIRT OR WATER.
- THE OIL TYPE INDICATED IN THE OPERATING MANUAL SHOULD BE USED IN THE ENGINE. OTHERWISE, THE FAILURES WHICH ARE LIKELY TO OCCUR WILL NOT BE COVERED BY THE WARRANTY.
- BATTERIES WILL NOT BE COVERED BY THE WARRANTY IF THEY ARE SUBJECTED TO BREAKAGE, EXCESSIVE ACID FILL OR HARDENING BY LEAVING UNCHARGED.
- GENERATING SETS, NEVER START OR STOP THE DIESEL ENGINE WHEN THE GENERATING SET IS UNDER LOAD. ENGINE SHOULD BE STARTED AND STOPPED AFTER LOAD IS DISCONNECTED AND THE GENERATING SET IS AT IDLE CONDITION. OTHERWISE, THE VALVES CAN BE SEIZED, THE VOLTAGE REGULATOR, TRANSFORMER AND DIODES CAN BE BROKEN DOWN. THESE CONDITIONS ARE NOT COVERED BY THE WARRANTY.
- OUR COMPANY DOES NOT TAKE THE RESPONSIBILITY OF THE DAMAGES ON THE MAINS SUPPLY CONTACTOR OF THE AUTOMATIC GENERATING SETS DUE TO OVERCURRENT, LOW OR HIGH VOLTAGE.
- NEVER REMOVE THE BATTERY TERMINALS WHILE THE GENERATING SET IS IN USE. EVEN A MOMENT OF DISCONNECTION CAN CAUSE A DAMAGE ON THE ELECTRONIC CLOSING RELAY OF THE CHARGE ALTERNATOR. THIS CONDITION IS NOT COVERED BY THE WARRANTY.
- FAILURES DUE TO OVERLOAD AND UNBALANCED LOAD IN EXCESS OF THE GENERATING SET POWER (SUCH AS ALTERNATOR AND CONTACTOR FAILURES) ARE NOT COVERED BY THE WARRANTY.
- WHEN THE MANUAL GENERATING SET IS STARTED, IT SHOULD BE WARMED BY OPERATING AT IDLE FOR 5 MINUTES. WHEN STOPPING THE DIESEL ENGINE, IT SHOULD BE UNLOADED AND THEN CONTINUED TO BE OPERATED FOR COOLING FOR 5 MINUTES BEFORE STOPPING. OTHERWISE, PROBLEMS WHICH ARE LIKELY TO OCCUR WILL NOT BE COVERED BY THE WARRANTY.

PREFACE

Thank you for purchasing products from our company.

The manuals will help you to operate and maintain the machines rightly. Please make sure to read the manuals carefully before the operating the machines. Then the generators can work in the best condition and prolong the life.

This manual will explain how to operate and service your generator set. If you have any questions or suggestions about this manual, please contact us by the email

. Consumers should notice that this manual might differ slightly from the actual product as more improvements are made to our products. Some of the pictures in this manual may differ slightly from the actual product as well. AKSA Group reserves the right to make changes at any time without notice and without incurring any obligation.

Please notice the following  warning.
If you will not operate the machines according to the manuals, there may be body injury and dead.

So you MUST operate the machines after the fully understanding of the manuals.

TABLE OF CONTENTS

Chapter 1 Technical Specifications and Data	1
1-1 Technical specifications and data.....	1
1-2 Basic operating parameters.....	2
1-3 General dimensions and overview of the generators.....	2
1-4 Parts name and control panel.....	3
Chapter 2 Operating the Diesel Generator	4
2-1 Main points of safety during operation of the generator.....	4
2-2 Preparation before operation.....	5
2-3 Checking the operation of the diesel engine.....	8
2-4 Starting the generator set.....	8
2-5 Proper operation of the generator set.....	9
2-6 Loading.....	10
2-7 Stopping the generator.....	11
Chapter 3 Maintenance	12
3-1 Maintenance schedules.....	12
3-2 Storing for long periods of time.....	13
Chapter 4 Troubleshooting	14
4-1 Troubleshooting procedures.....	14
4-2 Questions and doubts.....	14
Chapter 5 Circuit diagram	15
Appendix I Type of socket	18
Appendix II General power list of appliance	20

CHAPTER 1 TECHNICAL SPECIFICATIONS AND DATA

1-1 Technical specifications and data

Single-cylinder diesel generator

Item \ Type		AAP 4200 DE
Generator	Kind	Single phase
	Frequency(Hz)	50
	Max power (KVA)	4.5
	Rated power (KVA)	4.2
	Voltage (A.C)(V)	220V,230V,240V,110/220V,120/240V,115/230V
	Excitation mode	Self-excitation brushless or Self-excitation constant voltage(AVR)
	Revolution (r/min)	3000
	Voltage (D.C)(V)	12
	Current (D.C)(A)	7
	Noise level dB(A)/7m (0-100%load)	70-74
	Power factor cos ϕ	1
	Insulation grade	F
Diesel engine	Model of power	CF186F (E)
	Kind	4-stroke single-cylinder air cooled direct injection
	Max power (kW/rpm)	6.5
	Bore \times stroke (mm)	86 \times 70
	Cylinder displacement (ml)	406
	Cooling system	Force air-cooled
	Lubricating system	Pressure splash, duplex type lubrication
	Volume of lube oil (L)	1.65
	Start system	Electric start
	Fuel	Diesel fuel
Set	Fuel tank volume (L)	15
	Low oil pressure protection	Have
	Total weight (kg)	186
	Overall dimensions (mm)	970 \times 580 \times 785

Note: Get this power only after 30 hours' initial run.

1-2 Basic operating parameters

1-2.1 Under the given conditions, the generator will output the specified power in the table listed below.

Table 1

Height above sea level (ft)	Ambient temperature (F)	RH
0	+60 (+20 °C)	60%
<3280.8 (<1000 m)	41~104 (5-40 °C)	90%

1-3 General dimensions and overview of the generators

Please refer to the specification for the right dimension for different models.

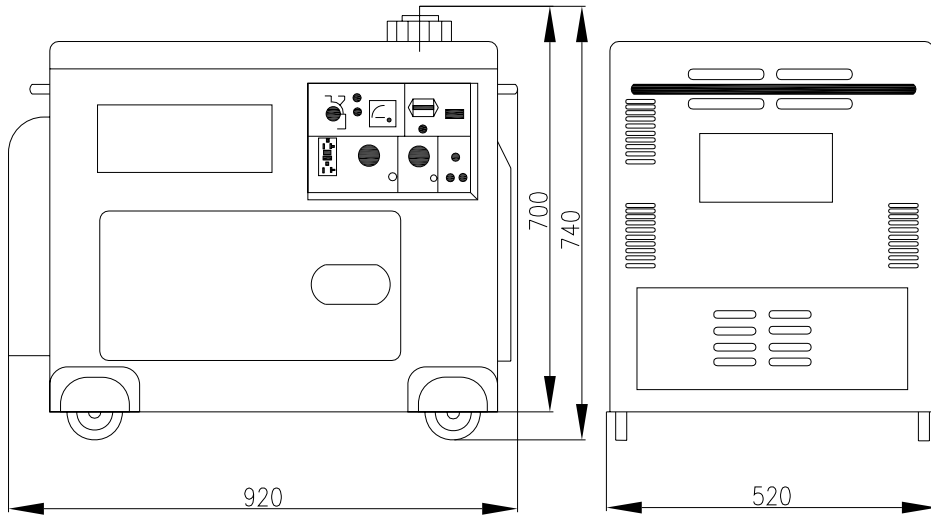

1-4 Parts name and control panel

1-4.1 Parts Name

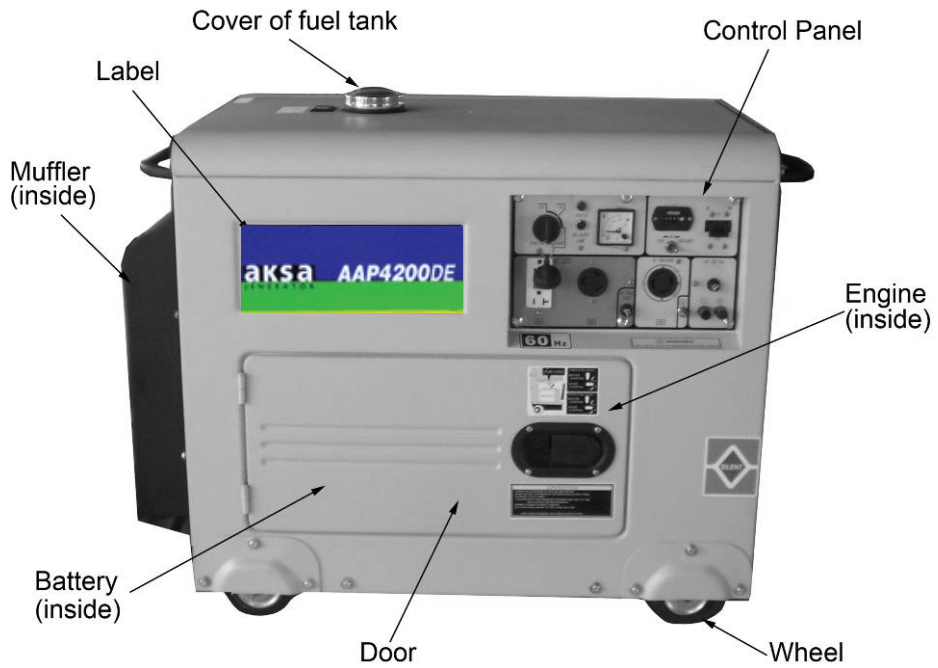

1-4.2 control panel

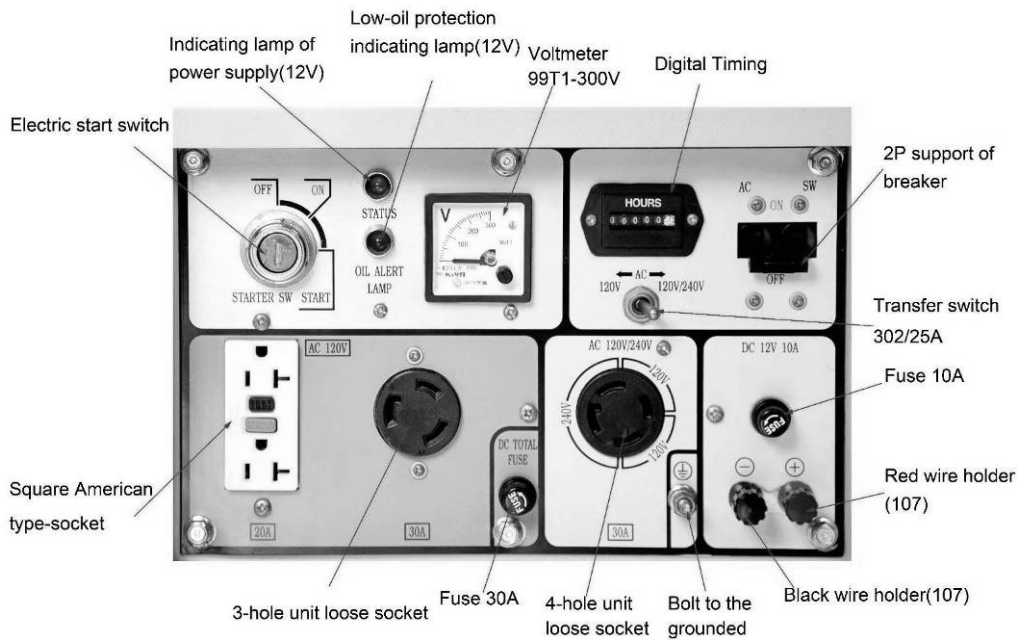

CHAPTER 2 OPERATING THE DIESEL GENERATOR

2-1 General main points of safety during operation of the generator set.



In order to operate the generator set safely, please follow all the instructions provided in this manual carefully. Doing so otherwise may lead to accidents and or equipment damage.

2-1.1 Fire prevention

- Do not use gasoline, kerosene or other fuels other than light diesel fuel.
- Keep all flammable fuels away from the generator as the generator may spark and ignite these gases.
- Keep the diesel generator at least 1.5 meters away from buildings and or other equipment.
- Always operate your diesel generator on a level site.

2-1.2 Prevention from inhaling exhaust gases.

Never inhales exhaust gases emitted by the engine. The exhaust gases contain toxic carbon monoxide.

Never operate your generator in places with poor ventilation. In order to operate this machinery indoors, a suitable ventilation system for the building is

required to draw the poisonous exhaust gases out.

2-1.3 Prevention from accidental burns

- Never touch the muffler and its cover when the diesel engine is running.
- Never touch the muffler and cover after the diesel engine has been used, as the muffler remains hot for a good period of time.

2-1.4 Electric shock and short circuits

- Never touch the generator if the generator is wet. Also never touch the generator if your hand is wet.
- Never operate your generator if the weather conditions call for any type of precipitation such as rain, snow, or fog.
- To prevent electrical shocks, the generator should be grounded. Please refer to Fig. 2-1 before beginning to use the electric generator.

Fig. 2-1

NOTE
When connecting devices to the generator, make sure all other devices are rated lower than the generators output. Any generator socket should not be overloaded over its regulated limit.



2-1.5 Other safety points

Before operating this generator, all operators should have a good knowledge of how to break the circuit if any accidents occur. Also, all operators should be familiar with all the switches and functions of the generator before using this machine. While operating the generator, wear safe shoes and suitable clothes during operation. Always keep children and animals away from the generator.

2-1.6 Battery

Wear protective gear when working with the battery to protect your eyes, skin, and clothing,. If you come in contact with the electrolytic liquid, wash it immediately with clean water. Also, if the electrolytic liquid comes in contact with your eyes, see a doctor immediately.

2-2 Preparation before operation

2-2.1 Fuel choices and fuel treatment

- Use only light diesel fuel. Otherwise it will be difficult to start the generator.
- The fuel should be filtered clean. Never let dust and water mix with fuel in the fuel tank. Otherwise it will clog the fuel lines and oil nozzles. It may also damage your pressure pump.

Note
It is dangerous to overfill the fuel tank. Never exceed the red piston in the filter.

Type	AAP4200DE
The effective volume of fuel tank:	14.5L

OPERATING THE DIESEL GENERATOR

- a. After purchasing fuel, put it into a drum and let it sit for 3-4 days. Otherwise it contains granule, which will result to clog the fuel lines.
- b. 3-4 days later, insert half of the fuel sucker into the drum, (water and impurities stay in the lower portion of the drum) .Otherwise they will be taken in. Contaminated fuel will cause accelerated wear to fuel system part.

⚠ NOTE

Never smoke near the opening of the fuel tank. Do not let sparks get near the fuel or fuel tank and do not overfill tank. After filling, tighten the fuel cap.

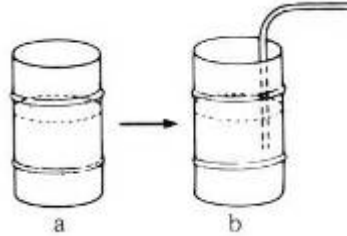

2-2.2 Check and fill engine oil

- Make sure the generator is on level ground and remove the dipstick from the engines. if not, the oil level of the engine which show us are wrong.
- Check if the oil level is between the high limit and low limit. If the engine is new or oil is not enough, fill the engine with the right engine oil(10W30).
- Put the dipstick back into the hole to check the engine oil level.



Oil dipstick

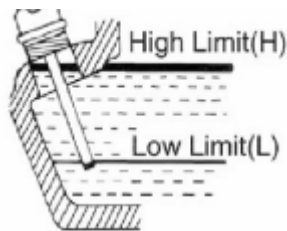

Capacity	Model	CF186F
Litre (US. gal)		1.65 (0.44)

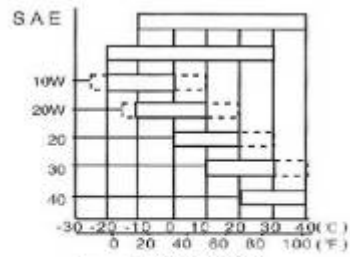

Be sure to use SAE 10W30, API grade CD or higher.

Choose the right engine oil

Engine oil is the most important factor in determining the life of your generator engine. If you use poor engine oil or if you don't change the oil regularly, the piston and cylinder will wear easily or seize up. Also, the life of the other parts in your engine such as bearings, and other rotating parts will shorten considerably.

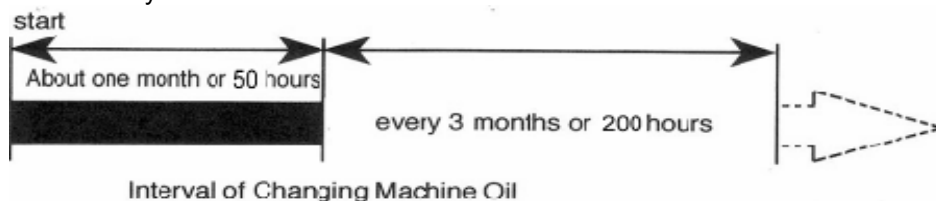

NOTE

Although there is an alarm system to check for low oil pressure, it is always a good idea to check the amount of oil inside the engine. If the oil level is low, fill it before starting the engine.

A good time to drain the oil from the engine is when the diesel engine is still hot. If the engine is fully cooled, it is more difficult to drain all the oil out or some impurities will remain in the engine.

WARNING

DO NOT fill engine oil when the machines are running.

2-2.3 Checking the air filter

(1) Open the cover of generators, you will see the air filter assembly.

(2) Loosen the butterfly nut of air filter, take the cover of the air filter off and take the air filter element out.



NOTE

- Do not use detergent to wash the air filter element.
- When the performance of the engine decreases or when the color of the exhaust gases is bad, exchange the filter element.
- Never start the engine without the air filter as foreign objects may enter the intake and damage the engine.

(3) After replacing the air filter element, replace the cover and tighten the butterfly nut firmly.

If not replace the air filter immediately, the dust in the air will not be adsorbed. In that case, it stands a good chance to block the air way.

2-2.4 Check the oil way

The fuel and oil in a new engine is drained before sold. Before you start the engine, please fill the fuel tank and engine oil first. Then, check to see if there are air bubbles in the engine. If there are, follow these procedures. Loosen the connecting nut between the oil injection pump and oil pipe. Bleed the air from the system until there are no more bubbles. Then replace the connecting nut and tighten it.

2-2.5 Check the generators

(1) Close the power switch and disconnect from any load. Otherwise it may cause electric shock. Even make injures or death.

⚠ WARNING

Make sure to close the power switch.
Make sure to ground the generators.

(2) How to use double voltage generators
Push the voltage switch to the right voltage you will use.

⚠ WARNING

Make sure to disconnect any load before starting the generators. It is very dangerous if not.

2-3 Checking the operation of the diesel engine

2-3.1 Low-pressure alarm system.

AKSA diesel engines have a low-pressure sensor system where if the oil pressure drops too low, the sensor will shut the engine off. The purpose of having this system is to ensure that the engine does not seize up. If there is not enough oil in the engine, the temperature of the oil will be raised too high. On the contrary, if there is too much oil in the engine, the engine oil can slow the engine down considerably.

2-3.2 How to open the case door/cover

(1) Open the case door: Pull the handle outward and open the door. Do these checks daily.

(2) Loosen the outer cover bolt of the air filter and outer cover of the oil nozzle, and then check the air filter.

(3) Check the outer cover of the oil nozzle. Loosen the butterfly nut and open the outer cover.

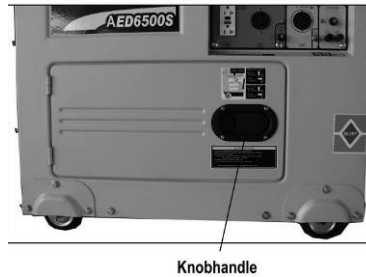

2-3.3 Engine break in

When you purchase a brand new engine, the engine must be properly broken in. The break in period is about 20 hours.

(1) Avoid overloading the engine when brand new

(2) Change the engine oil according to specifications. An oil change for a brand new engine is about 20 hours or every month, an older engine, the oil change is about 100 hours or three months.

If not breaking in, it will reduce the serving life, reliability and cost performance of the engine. At last, the life of the generator also be shortened.

2-4 Starting the generator set

2-4.1 Starting.

(1) Make certain the generator is on a " FLAT " or " LEVEL SURFACE ". If the engine is tilted, fuel spillage may result.

(2) Disconnect all electrical loads from the generator. Never start and stop the generator with electrical devices plugged in or turned on. Otherwise it will result

to short circuit, even break down the starter motor.

(3) Turn the Fuel Valve to the " ON " position. Otherwise fuel will be not enough to start the generator.

(4). Push the speed level to " run " Position. If do not so, the start of generator will be fail.

(5) Insert the ignition key to the " off " position.

(6) Electric Start: Turn the ignition key to the " Start " position and hold until engine starts. Otherwise it will be abnormal to electrify. (If the engine fails to start within five seconds, release the key and wait at least ten seconds before attempting to start the engine again. If holding on starting, it will heat up motor.)

(7) As engine warms up, move the ignition key to " on " position. Otherwise the fuel way will cause serious trouble.

2-4.2 Battery



NOTE

If you crank the starter too long, the battery may be drained too much to provide enough energy for proper engine ignition. Also, when the diesel engine is operating, let the key retain in the "ON" position.



IMPORTANT NOTE

All of our units come with a maintenance free battery. You do not need to add any battery acid.

2-5 Proper operation of the generator set

2-5.1 Operating the diesel engine

1. Pre-heat the diesel engine for 3 minutes under no load conditions.
2. First check the low oil pressure indication light in the panel. If the light is red, please fill into enough oil.
3. Do not adjust the speed limit regulation bolt or the fuel adjustment bolt. These bolts have been set by the factory already, changing them will affect the properties of the engine performance.

2-5.2 Checks during engine operation

1. Check to see if there are abnormal noises. Check the joint of oil passages, fuel passages, water passages and air passages frequently to find out whether there is any leakage. If any, remove at once. Otherwise serious troubles may be caused.
 2. Check to see if the performance is good or bad.
 3. Check the color of the exhaust gases (whether it is too black or too white).
- If any of these conditions exist, stop the engine and find the cause of the

problem. If no problems are found, please contact your local dealer or our nearest company branch.

2-6 Loading

2-6.1 Connecting Electrical Loads:

1. Let the engine stably and warm up for a few minutes after starting.
2. Plug in and turn on the desired VOLTAGE AC Output with electrical loads.



IMPORTANT NOTE

DO NOT connect 3-phase loads to SINGLE PHASE Diesel Generator.
DO NOT overload this generator.

To prolong the life of your generator and properly connect your appliances, please follow these steps to add electrical load:

3. Start the generator with NO ELECTRICAL LOAD ATTACHED.
4. Allow the engine to run for several minutes to STABILIZE.
5. Plug in and turn on the first item. It is best to attached the item with the LARGEST LOAD first.
6. Allow the engine to stabilize.
7. Plug in and turn on the next item.
8. Allow the engine to STABILIZE.
9. Repeat step 4-5 for each capacity when adding loads.



NOTE

Do not start more than two devices simultaneously. Each device should be started one by one to prevent overloading the generator.
The generator should be running at 3600 revolutions per minute in order to achieve the (60 Hz) frequency. The speed of the engine can be adjusted from the speed governor.

2-6.2 Output of electricity

1. Raise the revolutions per minute (turn the speed handle to the max setting) of the generator to get the maximum power out of the generator. If not, the automatic voltage regulator device will excite and doing this for long periods of time will cause the AVR to burn. For the rated speed of the generator, please refer to Chapter 1, item 1-1 technical specification and data.
2. Observe the pointer of the voltmeter, it should point to the voltage you need 5%. Meanwhile put the switch in the GEN (generator) position. The AC voltage from the socket of the power supply can be output.

2-6.3 Charging the battery

1. For the electric starter on the generator sets, the 12V battery is automatically charged through the regulator on the side of the engine when it is running.
2. If the generator is not used for long periods of time, the battery should be disconnected to avoid energy loss from the battery.
3. Do not connect the negative and positive terminals of the battery together at

OPERATING THE DIESEL GENERATOR

any time. Doing so will damage the battery and cause serious injuries.

4. Do not reverse the polarities when attaching the battery cables to the battery. Doing so will damage both the battery and the electric starter.
5. When charging the battery, the battery produces flammable gases. Do not smoke, let flames, and sparks get near the battery while it is charging as this may cause a fire.

To avoid sparking while connecting the cables to the battery, first, connect the cables to the battery then to the motor. To disconnect battery cables, first disconnect the motor end of the cable.

2-7 Stopping the generator

1. Take the electrical load off the generator, when you want to stop the generators.
2. Move the air switch to “off” position. If not, the short circuit will appear.
3. Put the speed handle in the “RUN” position and let the engine run for 3 minutes after unloading. Do not stop the diesel engine immediately let it warm down. Stopping the diesel engine suddenly may raise the temperature of the engine abnormally and lock the nozzle and damage the diesel engine.

NOTE

1. If you cannot stop the engine with a load on it, then remove the load first than stop the engine.
2. Press down on the brake handle.
3. If equipped with an electric starter, turn the key to the “Off” position.
4. Put the fuel handle to the “S” position.

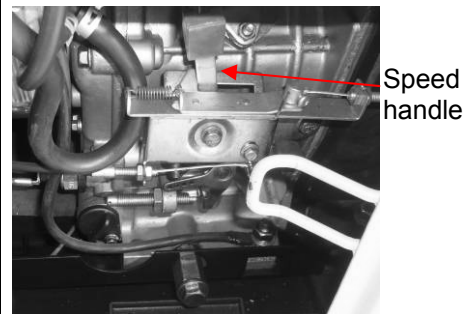

4. Put the ignition key to “off” position. Then the generators will stop.
5. Move the speed level to “stop” position, which make sure to cut off the fuel way.
6. Close the fuel valve. But don't stall the generator by turning off the cock of the fuel tank in case air enters fuel passages to cause difficult starting next time.

CHAPTER 3 MAINTENANCE

3-1 Maintenance schedules

Keeping your generator well maintained will prolong the life of your generator. Everything needs to be checked including the diesel engine, generator, control cabinet, and frame. For overhauling procedures, please refer to the instruction manual of the relative subassembly. If you need these manuals, please call our company and we will send you one.

Before starting the maintenance, make sure the diesel engine is off.

Please refer to the Table 3-1 for the proper maintenance schedule.

Table 3-1. Maintenance schedule for diesel generator set

Time Item	Everyday	After 1 month or 50hours	Every 3 month or 200 hours	Every 6 month or 400 hours	Every 1year or 1000 hours
Check the fuel level and refill	○Before starting				
Drain the fuel tank		○			
Check and fill enough engine oil	○				
Clean the fuel filter			○		
Check fuel oil leakage	○after every operating				
Check and screw each fastened part	○			●screw the bolt of cylinder head firmly	
Check injector				●	
Check injection pump					●
Check fuel pipe				●If necessary exchange it	
Check the lube. oil level in the oil pan and refill	○before starting				
Replace the lube. oil		○the first time	○the second time and afterward		
Clean lube. Oil filter		○the first time	○the second time and afterward		
Check the air cleaner element		○the first time	○the second time and afterward		
Change the core of air filter	If damaged or smeary , change it in time				
Check the battery liquid level and refill	○				
Adjusting the intake and exhaust valve clearance		●the first time		●the second time and afterward	
Grind air intake and air exhausted gate					●
Exchange piston ring					●
Check electric brush and slide ring				●	
Check insulation resistance	The time of stop is over 10 days ○				

Note: the quality period of the injector and injection pump is 1500 hours or two years. There into,● means it should operate with special tools, or can be checked by dealer.

3-1.1 Changing the engine oil (every 100 hours)

Take the oil cover off. Remove the oil drain plug when the diesel engine is still hot. Be careful of hot oil and hot engine as you may get burned. The bolt is located at the bottom of the cylinder. After draining the oil, put the bolt back and tighten it. Then fill with the proper engine oil to the proper level.

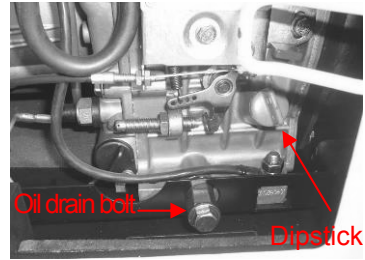

3-1.2 Air filter maintenance schedule

1. Clean air-filter every 6 months or 500 hours of operation.
2. If necessary, exchange it.
3. Do not use detergent to clean air filter element.



NOTE

Never start the engine without the air filter. This can cause serious damage to the engine if foreign objects enter the intake system. Always change the air filter on time.

3-1.3 Fuel filter maintenance

1. The fuel filter should be cleaned often to keep the engine running at maximum performance.
2. The recommended time period for cleaning the fuel filter is 6 months or 500 hours of operation.
 - a. To do this, first drain the fuel from the fuel tank.
 - b. Loosen the small screws on the fuel switch and remove the fuel filter from the port. Use diesel fuel to clean the fuel filter. Also, remove the fuel injector and clean the carbon deposit around it. The recommended time period for this is 3 months or 100 hours.

3-1.4 Cylinder head bolt tensions

The cylinder head bolts should be tightened to specifications please refer to the diesel engine manual for specifications and the special tools required to do this.

3-1.5 Battery check

Make sure the battery acid is full. The engine uses a 12V battery. Due to numerous starting cycles, the battery acid may be used up. Also, before filling, verify that the battery is not damaged in any way. Add distilled water to the battery when filling. Perform checks on the battery once a month.

3-2 Storing for long periods of time

If your generator needs to be stored for long periods of time, the following preparations should be made.

1. Start the diesel engine for 3 minutes then stop it.
2. When the engine is still hot, change the engine oil with new engine oil of the proper grade.
3. For electric started generator, press the decompression handle down and crank the engine for 2-3 seconds. To do this, put the starter switch in the "Start" position. (Do not start the diesel engine)
4. Clean the engine and store it in a dry place.

CHAPTER 4 TROUBLESHOOTING

4-1 Troubleshooting procedures

	Causes of malfunction	Remedy
Diesel cannot be started.	Not enough fuel	Add enough fuel
	The switch of fuel is not at "OPEN" position.	Turn the switch of fuel to "OPEN" position.
	High-pressure pump and nozzle do not inject fuel or the injected amount is less.	Disassemble the nozzle and adjust it at test table.
	Speed control lever is not at "RUN" position.	Turn speed control lever to "RUN" position.
	Check level of lubrication oil.	The standard oil amount of lubricating oil should be between high graduation "H" and low graduation "L".
	It is not quick and powerful to pull reactive starter.	Start diesel engine in accordance with the requirements of "start operation procedures".
	Nozzle exist dirt.	Clean the nozzle.
	Accumulator has not electricity.	Charge the accumulator or exchange it.
Generator cannot generate electricity and has not welding voltage	Master switch (NFB) is not be switched on.	Turn master switch handle to "ON" position.
	Carbon brush of generator was worn. The contact is bad.	Exchange the carbon brush.
	The contact of socket is bad.	Adjust the contact feet of socket.
	The rated revolution of engine cannot be reached.	Make it reach to the rated revolution in accordance with the requirements.
	AVR automatic governor is damaged.	Exchange it.
	The potentiometer of current regulation for electric welding is damaged.	Exchange it.

If you are still having trouble, please contact with your nearest dealer or with our company directly if necessary.

4-2 Questions and doubts

If you do not understand anything or have any questions, please feel free to contact our company directly.

of some information you should have ready before contacting us.

1. Model of diesel engine generator and engine model number.
2. State of residency.
3. Number of hours of operating equipment along with the problem that occurred.
4. A detailed condition and time when the problem occurred, in other words, climate and atmosphere.

CHAPTER 5 CIRCUIT DIAGRAM

Figure 5-1 single-phase double voltage circuit diagram

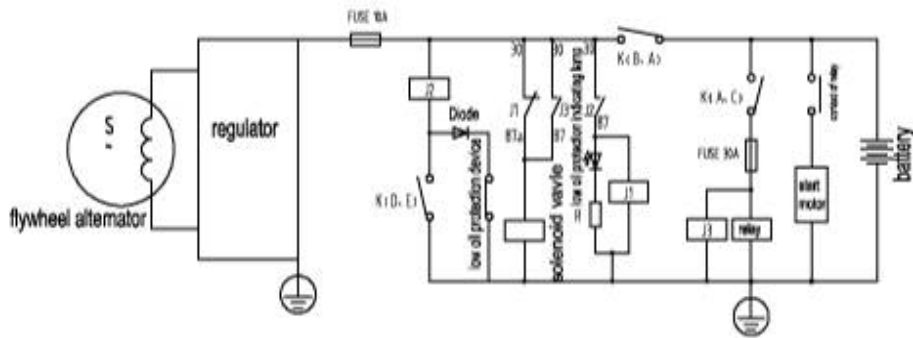
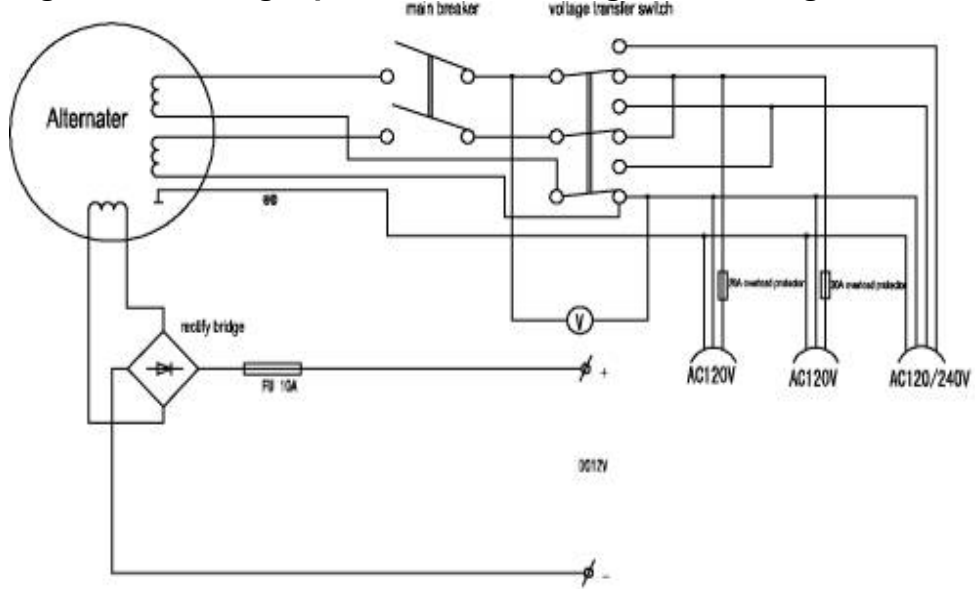

switch list

contact switch	A	B	C	D	E
0 stop				•—•	
I run	•—•				
II start	•—•	•—•			

main breaker collocate list

model	main breaker
CE03500S	10A
CE06500S	20A

CIRCUIT DIAGRAM

Figure 5-2 single-phase single voltage circuit diagram

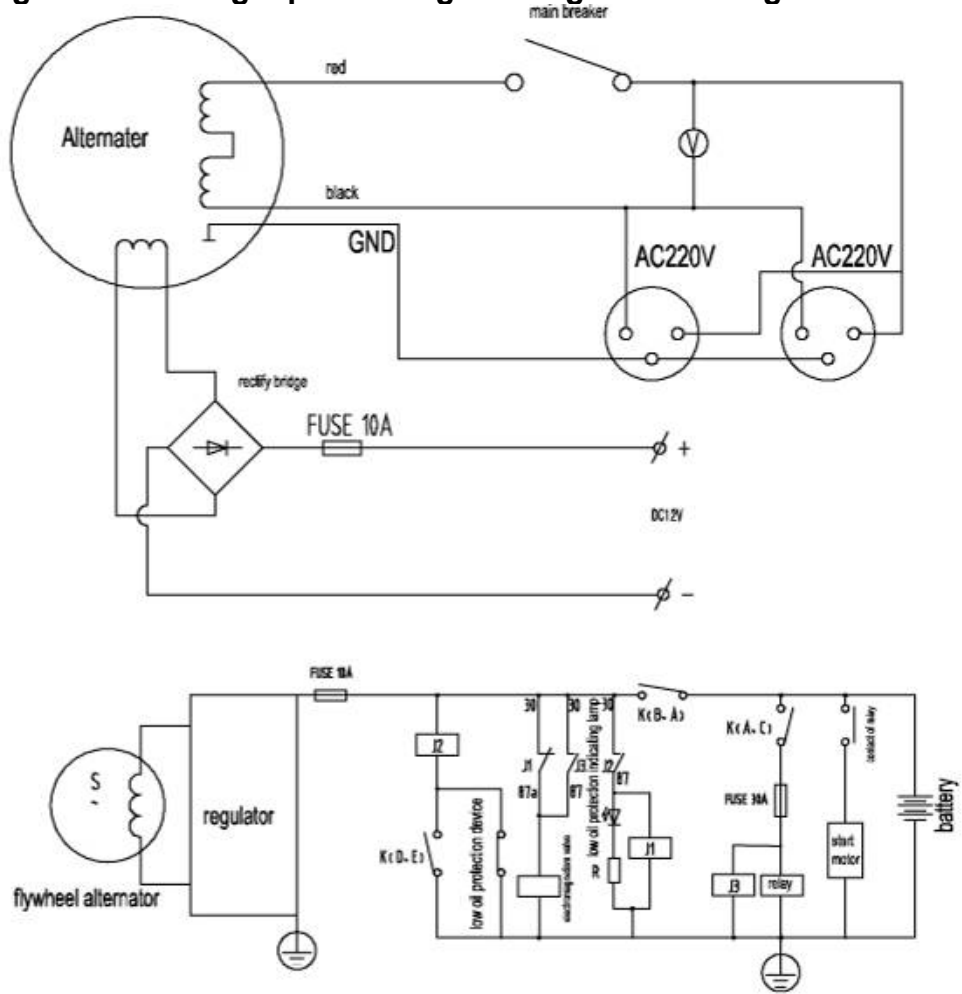

switch list

contact switch	A	B	C	D	E
0 stop				⊖	
I run	⊖				
II start	⊖	⊖			

main breaker collocate list

model	main breaker
CED3500S	16A
CED6500S	20A

Figure 5-3 three-phase circuit diagram

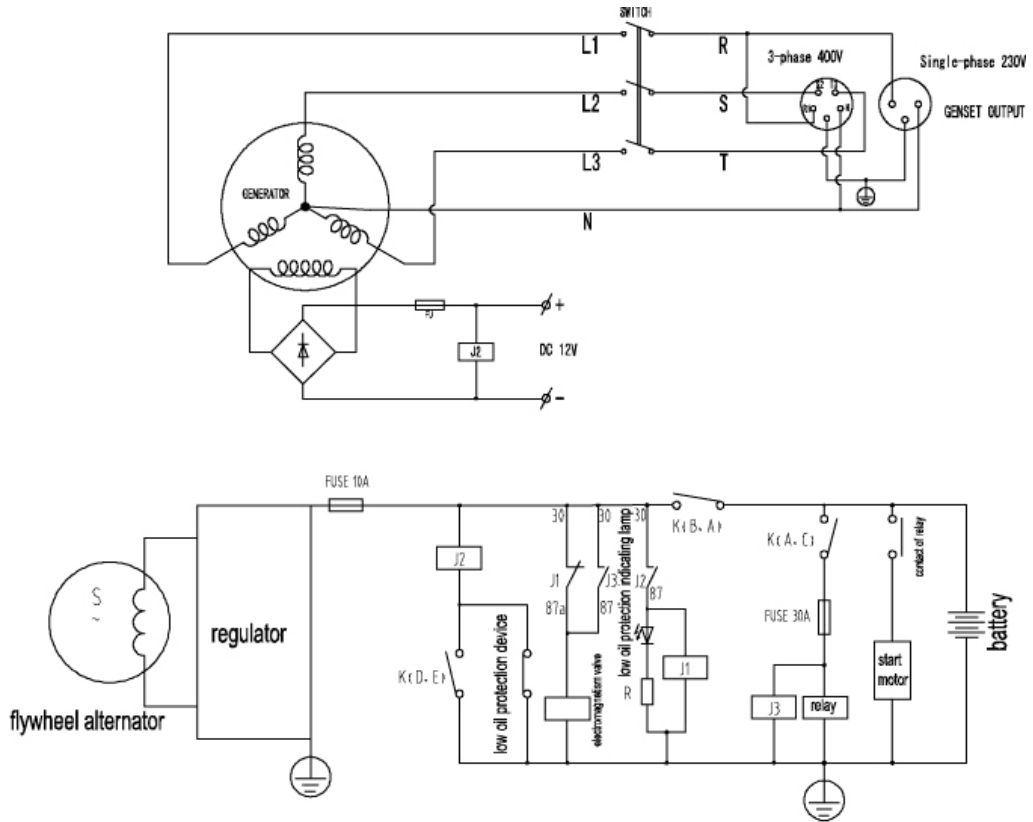









switch list

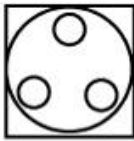

contact switch	A	B	C	D	E
0 stop				○—○	
I run	○—○				
II start	○—○	○—○			

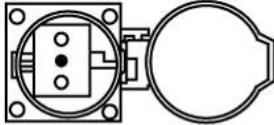
main breaker collocate list

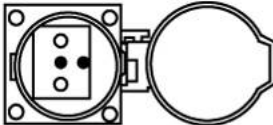
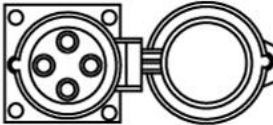
model	main breaker
CEd6500S	10A

Appendix I : Types of sockets

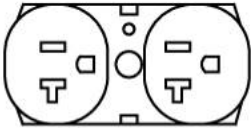
Code	Description	Specification	Picture
S01	S.A socket	25A, 250V	
S02	British socket	32A, 240V	
S03	British socket	16A, 240V	
S04	Square American type-socket	20A, 120V	
S05	Germany socket	16A, 250V	
S06	Three-phase five holes socket	16A, 415V	
S07	French socket	16A, 250V	
S08	Three-phase four holes socket	16A, 215V	
S09	American type 4-hole unit loose socket	30A, 250V	

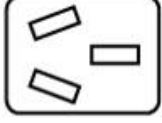
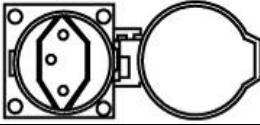
Code	Description	Specification	Picture
S10	American double socket	20A, 125V	
S11	3-hole unit loose socket (UL-authentication optional)	30A, 250V	
S12	Australian socket	16A, 250V	
S13	Swiss socket	10A, 250V	

Appendix II : General power list of appliance

To select the correct size generator for your needs you should make a list of which tools and/or appliances you intend to operate with your generator. The chart below contains approximate wattages and should give you an idea of the size generator you will need. After you make your list of devices to be used, (be sure to consider starting wattages) you will add the total watts and select the generator that can supply that amount of power.

House Hold	Running Wattage Requirements	Starting Wattage Requirements
Coffee Maker	1750	1750
Dishwasher	1450	1800
Electric Fry Pan	1300	1300
Electric Range		
6 Inch Elements	1500	1500
8 Inch Elements	2100	2100
Microwave Oven 625 watts	625	800
Refrigerator or Freezer	700	2200
Toaster 2-slice	1050	1050
Toaster 4- Slice	1650	1650
Automatic Clothes Washer	1150	2300
Clothes Dryer Gas	700	1800
Dehumidifier	650	800
Electric Blanket (queen size)	650	800
Garage Door Opener ¼hp	550	1100
Garage Door Opener 1/3 hp	725	1400
Furnace Fan 1/8 hp	500	1000
Furnace Fan 1/6 hp	750	1500
Furnace Fan ¼ hp	900	1800
Furnace Fan 1/3 hp	1000	1800
Furnace Fan ½hp	1200	1500
Hair Dryer	300 - 1500	300 - 1500
Clothes Iron	1200	1200
Lights	As Indicated	As Indicated
Radio	50 - 200	50 - 200
Well or Sump Pump 1/3 hp	750	1500
Well or Sump Pump 1/2 hp	1000	2000
Well or Sump Pump 1 hp	2300	4500
Color Television 13 to	300	300

House Hold	Running Wattage Requirements	Starting Wattage Requirements
32		
VCR	50	50
Computer	150	150
Modem	25	25
Printer	100	100
Vacuum Cleaner Upright	800	1100
Vacuum Cleaner Canister	1100	1500
Central Air Conditioner		
10.000 BTU	1500	2200
20.000 BTU	2500	3300
24.000 BTU	3800	4950
40.000 BTU	6000	7800
Air Compressor		
½ hp	1000	2000
1 hp	1500	4500
1½hp	2200	6000
2 hp	2800	7700
Bench Grinder 6-inch	720	1000
Bench Grinder 8-inch	1400	2500
Bench Grinder 10-inch	1600	3600
Electric Cultivator 1/3 hp	700	1400
Electric Grass Trimmer	500	650
Drum Mixer ¼hp	700	1400
Mercury/Halogen	1000	1000
Floor Polisher		
16-inch, ¾hp	1400	3100
20-inch, 1hp	1600	4500
Hand Drill ¼inch	350	350
Hand Drill 3/8 inch	400	400
Hand Drill ½inch	600	600
Submersible		
Water Pump 400gp	200	400
Water Pump Centrifugal Type	500	650
Wet And Dry Vacuum		
1.7 hp	900	900
2.5 hp	1300	1300
Saws		
Worm Drive (chop saw)	1800	2600
Circular Saw 6½inch	800	1200
Circular Saw 7½inch	1400	2300

House Hold	Running Wattage Requirements	Starting Wattage Requirements
Circular Saw 8 ¼ inch	1800	3000
Electric Chain Saw	1100	1400
Table Saw 9 inch	1500	3000
Table Saw 10 inch	1800	4500
Electric Welder 70 amp	2800	2800
Band Saw	1100	1400
Electric Fence, 25 miles	250	250
Stock Tank De-Icer	1000	1000
Grain Cleaner	650	1000
Portable Conveyer ¹ / ₂ hp	1000	2400
Grain Elevator ³ / ₄ hp	1000	2400
Milk Cooler	1100	2300
Mixer 3¹/₂Cubic Feet		
³ / ₄ hp	2800	7700
Milking Machine, 2 hp	1100	2300

AKSA JENERATÖR YETKİLİ SERVİS NOKTALARI

İSTANBUL AVRUPA YAKASI

AVCILAR
MUSTAFA KEMAL PAŞA MAH. YILDIRIM BEYAZIT CAD. DEMET SOK. NO:132 AVCILAR/İSTANBUL
T:0 212 428 66 66 PBX F:0 212 423 22 22

BAĞCILAR
ORTAK BÖLGE (GÖKSU) FATİH, ZEYTİNBURNU, GAZİOSMANPAŞA, EYÜP
MERKEZ MAH. ATATÜRK CAD. NO:24 YENİBOSNA T:0212 630 79 80/0212 630 79 98

KAĞITHANE
ÇAĞLAYAN MAH. KAĞITHANE CAD. NO:93 KAĞITHANE
T:0212 222 13 38 PBX F:0212 210 08 81

KARAKÖY
NECATİBEY CAD NO.74 KARAKÖY / İSTANBUL T: 0212 251 92 48 - 293 07 32 - 33 F: 0212 251 92 64
DOLAPDERE SAN. SİT. 13.ADA NO:9 İKİTELLİ T: 0212 671 35 48 - 49 F: 0212 671 35 41

SEFAKÖY
YEŞİLOVA MAH. DİLEK SOK. NO:2 KÜÇÜKÇEKMECE
T:0212 425 65 80 (3 HAT) F:0212 425 65 84

İSTANBUL ANADOLU YAKASI

KADIKÖY
ESKİ ÜSKÜDAR YOLU CAD. MEZARLIK SK. NO:4 İÇERENKÖY
T:0216 469 58 58

PENDİK
AYDINEVLER ÂŞİK VEYSEL SOK. AK PLAZA NO:24 KÜÇÜKYALI/MALTEPE
T:0216 489 68 68 PBX F:0216 489 21 60

İSTANBUL DIŞI SERVİS NOKTALARI

ANKARA
ÇETİN EMEÇ BULVARI 2.CAD. 1309 SK. NO:7/A ÖVEÇLER
T:0312 472 71 71 F:0312 472 76 01

ADANA
TURHAN CEMAL BERİKER BUL. MERKEZ CAD.
ADANA İŞ MERKEZİ A BLOK NO:24/27 YEŞİLOBA SEYHAN
T:0322 428 11 61 PBX F: 0322 428 15 40

ANTALYA
YEŞİLOVA MAH. ASPENDOS BULVARI 196-1
T:0242 322 16 88 – 322 91 88 F:0242 322 97 55

BODRUM
ATATÜRK BUL. BEYLİKKIRLARI MEVKİİ
BALKANOĞLU-2 İŞ MERKEZİ G-BLOK NO:1 KONACIK
T:0252 358 70 30 F: 0252 358 70 25

BURSA
NİLÜFER TİC. MRK. ALAADDİNBEY MAH. 70 SK.
NO:30/A NİLÜFER
T:0224 443 53 15-16-17-18 F:0224 443 53 15

DENİZLİ
İZMİR ASFALTI NO:56 GÜMÜŞLER
T:0258 371 71 10/372 08 44 F:0258 372 09 46

GAZİANTEP
FATİH MAH. FEVZİ ÇAKMAK BULVARI NO:152 ŞEHİTKÂMİL
T:0342 321 39 59 F:0342 321 37 67

İZMİR
KAZIM DİRİK MAH. YENİYOL ANKARA CAD.
NO:75 BORNOVA
T:0232 461 82 82 F:0232 462 24 63

KAYSERİ
OSMAN KAVUNCU CAD. SOYLUM APT. NO:185/A
MELİKGAZİ T:0352 336 17 42-43 F: 0352 336 17 40

DİYARBAKIR
URFA YOLU 1. KM. DR. SİTKİ GÖRAL CAD.
VELAT 3 APT.ALTİ NO:1
T:0412 238 04 44 PBX F:0412 238 10 11

MARMARİS
DATÇA YOLU CAD. NO:14/B
T:0252 413 58 93 F: 0252 413 85 93

TRABZON
YAVUZ SELİM BULVARI MANOLYA SİTESİ NO:281
T:0462 230 10 60-61 F: 0462 230 10 64

BRANCH OFFICES & WAREHOUSES



ALGERIA

Aksa Algeria
Chemin du Parc d'Attraction
Coopérative El Baraka No: 417 Tixerain
Bir Mourad Rais / Alger
T : + 213 21 40 26 72
F : + 213 21 40 27 94
e-mail: aksaalgeria@aksa.com.tr



KAZAKHSTAN

Aksa Kazakhstan Ltd.
M 54-6 Abdullinyh Str.
Corner of Tole Bi Str.
Almaty - Kazakhstan
T : + 7 727 250 67 31 / 250 67 41
F : + 7 727 250 67 91
e-mail : aksa@arna.kz



U.A.E

Aksa Middle East FZE
Post Box No.18167 Warehouse
No,RA08 / LC07
Jebel Ali Free Zone Dubai
United Arab Emirates
T : + 971 4 880 9140
F : + 971 4 880 9141
e-Mail : sales@aksa.ae



CHINA

Aksa Power Generation
(Changzhou) Co. Ltd.
Export Processing Zone
Xinzhu Road, Plant A1-A2,
Changzhou/China
T : + 86 (0)51985150205
F : + 86 (0)51985150130
e-mail : aksa@aksapowergen.com



RUSSIA

000 AKCA
107031, Petravka, 27
Moscow - Russia 7108862
T : + 7 495 710 88 62
F : + 7 495 641 52 00
e-mail : info@aksarussia.ru



UNITED KINGDOM

Aksa International (UK) Ltd
Unit 6, Pine Court Walker Road,
Bardon Hill Coalville Leicestershire,
LE67 1SZ U.Kingdem
T : + 44 (0) 1530 837 472
F : + 44 (0) 1530 519 577
e-mail: sales@aksa-uk.com



IRAQ

Aksa Iraq
Sahet Al-Wathik,
Al Wahda
St.909 Baghdad - Iraq
T : + 964 7901 916 086
F : + 964 7901 916 089
e-mail: export@aksa.com.tr



SINGAPORE

Aksa Far East (Pte.) Ltd.
94 Tuas Avenue 11
Singapore 639103
T : + 65 6863 2832
F : + 65 6863 0392 / 6863 2956
e-mail: aksafe@aksafareast.com.sg



VIETNAM

43 Le Thi Hong Gam,
Dist. 1, HCM City - Vietnam
T : + 84 8,39147014
F : + 84 8,39147015
e-mail : apd@aksa.com.tr



AKSA JENERATÖR SANAYİİ A.Ş.



DECLARATION OF CONFORMITY AT – UYGUNLUK BEYANI

Üretici / Manufacturer : AKSA Jeneratör San.A.Ş.
Adres / Adress : Gülbahar Cd. 1.Sokak, Güneşli 34212 İstanbul / Türkiye
Ürün Kodu / Product Code : AAP 4200DE /.....
Ürün Açıklaması / Production Description : Diesel Portable Genset
Dizel Portatif Jeneratör

Deklerasyon / Declaration

AKSA Jeneratör San. A.Ş olarak, yukarıda bilgileri verilmiş olan ürünün aşağıdaki Avrupa Birliği direktiflerine, standartlara ve bunların gerektirdiği şartlara uygun olduğunu beyan ederiz.

On behalf of AKSA Jeneratör San. A.Ş, We declare that above information in relation on the supply/manufacture of this in product is in conformity with the below stated standarts, EC directives and provisions of them.

Avrupa Birliği Direktifleri / EC Directives

2006/42/AT : Makine Emniyeti Yönetmeliği
2006/42/EC : Machinery Safety Directive
2004/108/AT : Elektromanyetik Uyumluluk Yönetmeliği
2004/108/EC : Electromagnetic Compatibility Directive
2006/95/AT : Alçak Gerilim Yönetmeliği
2006/95/EC : Low Voltage Directive

Standartlar / Standarts

- TS EN ISO 12100-1:2007; Makinelerde Güvenlik - Temel Kavramlar, Tasarım İçin Genel Prensipler -Bölüm 1: Temel Terminoloji, Metd EN ISO 12100-1:2003 ; Safety of machinery — Basic concepts, general principles for design-Part 1: Basic terminology, methodology
- TS EN ISO 12100-2:2007 ; Makinelerde güvenlik – Temel kavramlar, tasarım için genel prensipler -Bölüm 2: Teknik prensipler TS EN ISO 12100-2:2003 ; Safety of machinery — Basic concepts, general principles for design-Part 2: Technical Principles
- TS EN 614-1 ; Makinelerde Güvenlik-Ergonomik Tasarım Prensipleri-Bölüm 1:Terminoloji ve Genel Prensipler EN 614-1:2006 ; Safety of machinery-Ergonomic design principles-Part 1-Terminology and general principles
- TS EN 60204-1 ; Makinelerde güvenlik - Makinelerin elektrik teçhizatı - Bölüm 1: Genel kurallar EN 60204-1:2006 ; Safety of machinery-Electrical equipment of machines General Requirements
- TS EN 12601 ; Gidip Gelmeli İçten Yanmalı Motor Tahrikli Jeneratör Grupları- Güvenlik EN 12601:2001 ; Reciprocating internal combustion engine-driven generating sets-Safety
- TS EN 61000-3-2 ; Elektromanyetik Uyumluluk (EMU)-Bölüm 3-2: Sınır Değerler-Harmonik Akım Emisyonlar İçin Sınır Değerler BS EN 61000-3-2 ; Electromagnetic compatibility (EMC). Limits for harmonic current emissions

Yayım / Issued by : AKSA Jeneratör San. A.Ş
Yer-Tarih / Place-Date : İstanbul -
Firma Adına Yetkili / Name of Authorized Representative : Necati Baykal
Unvan / Title : General Manager
İmza / Signature :

SANAYİ VE TİCARET BAKANLIĞI

GARANTİ BELGESİ

GARANTİ BELGESİ

Belge Numarası : **85233**

Belge İzin Tarihi : **18-06-2010**

Bu belgenin kullanılmasında; 4077 sayılı Tüketicinin Korunması Hakkında Kanun ve bu Kanuna dayanılarak yürürlüğe konulan Garanti Belgesi Uygulama Esasları'na Dair Yönetmelik uyarınca, T.C. Sanayi ve Ticaret Bakanlığı Tüketicinin ve Rekabetin Korunması Genel Müdürlüğü tarafından izin verilmiştir.

Sezer TURHAN
Bakan a.
GEN.MÜDÜR YARD.



AKSA
JENERATÖR

İMALATÇI VEYA İTHALATÇI FİRMANIN

GARANTİ ŞARTLARI

Ünvanı : AKSA JENERATÖR SANAYİ ANONİM ŞİRKETİ
Adresi : Gülbahar Cad. 1. Sok. 34212
Güneşli / İSTANBUL
Telefon : (0212) 478 66 66 (pbx)
Telefax : (0212) 550 53 38

FİRMA YETKİLİSİNİN

İmzası ve Kaşesi :
MALIN :
Cinsi : JENERATÖR
Markası : AKSA JENERATÖR
Modeli :
Seri No :
Teslim Tarihi ve Yeri :
Azamî Tanım Süresi : 30 İŞ GÜNÜ
Garanti Süresi : 2 (iki) YIL

AKSA JENERATÖR SANAYİ A.Ş.

SATICI FİRMANIN
Ünvanı :
Adresi :
Tel-Telefax :
Fatura Tarih ve No :
TARİH - İMZA - KAŞE

- 1- Garanti süresi malın teslim tarihinden itibaren başlar ve 2 (iki) yıldır .
- 2- Malın bütün parçaları dahil olmak üzere tamamı firmamızın garantisine kapsamındadır.
- 3- Malın garanti süresi içerisinde arızalanması durumunda, tamirde geçen süre garanti süresine eklenir. Malın tamir süresi en fazla 30 (otuz) iş günüdür. Bu süre mala ilişkin arızanın servise istasyonuna, servis istasyonunun olmaması durumunda, malın satıcısı, bayii, acentası, temsilciliği, ithalatçısı veya imalatçısından birisine bildirim tarihinden itibaren başlar. Sanayi malının arızasının 15 iş günü içerisinde giderilememesi halinde, imalatçı veya ithalatçı; malın tamiri tamamlanmaya kadar, benzer özelliklere sahip başka bir sanayi malını tüketicinin kullanımına tahsis etmek zorundadır.
- 4- Malın garanti süresi içerisinde, gerek malzeme ve işçilik gerekse montaj hatalarından dolayı arızalanması halinde, işçilik masrafı, değiştirilen parça bedeli ya da başka herhangi bir ad altında hiçbir ücret talep etmeksizin yapılacaktır.
- 5- Tüketicinin onarım hakkını kullanmasına rağmen malın,
 - Tüketicije teslim tarihinden itibaren beşirlenen garanti süresi içinde kalmak kaydıyla bir yıl içerisinde, aynı arızayı ikiden fazla tekrarlaması veya farklı arızaların dörtten fazla ortaya çıkması sonucu, maldan yararlanamamasının süreklilik kazanması,
 - Tamiri için gereken azamî sürenin aşılması,
 - Firmamızın servis istasyonunun mevcut olmaması halinde sırasıyla; satıcı, bayii, acentası, temsilciliği, ithalatçısı veya imalatçısı-üreticisinden birisinin düzenleyeceği raporla arızanın tamirinin mümkün bulunmadığını belirlemesi, durumlarında tüketici malın ücretsiz değiştirilmesini, bedel iadesi veya ayıp oranında bedel indirimi talep edebilir.
- 6- Malın kullannya kılavuzunda yer alan hususlara aykırı kullanımasından, kaynaklanan arızalar garanti kapsamı dışındadır.
- 7- Garanti belgesi ile ilgili olarak çıkabilecek sorunlar için Sanayi ve Ticaret Bakanlığı, Tüketicinin ve Rekabetinin Korunması Genel Müdürlüğü' ne başvurulabilir.

Not : Servisin Müdahalesi sırasında müşteri tarafından bu belge veya fatura ibraz edilmek zorundadır.

Genel Müdürlük / Head office

Aksa Jeneratör Sanayi A.S.

Gulbahar Caddesi 1. Sokak Gunesli 34212 Istanbul, TURKEY

Tel: +90 212 478 66 66 (pbx) Fax: +90 212 657 55 16

e-mail: aksa@aksa.com.tr

Aksa Servis ve Yedek Parça / Aksa Service & Spare Parts

TÜRKİYE

Murat Bey Beldesi,

Güney girişi Cad. No: 8

34540 Çatalca / İSTANBUL

T : + 90 212 887 11 11

F : + 90 212 887 10 20

e-mail: info@aksaservis.com.tr

Aksa Kiralama / Aksa Rental

TÜRKİYE

Murat Bey Beldesi,

Güney girişi Cad. No: 8

34540 Çatalca / İSTANBUL

T : + 90 212 887 12 12

F : + 90 212 887 10 20

e-mail: info@aksaservis.com.tr

Fabrikalar / Factories

TURKEY

Tasocagi Yolu No: 22

Mahmutbey - Bagcilar

Istanbul, TURKEY

Tel : +90 212 446 43 01

Fax : +90 212 446 43 00

CHINA

Export Processing Zone

Xinzhu Road, Plant A1 - A2,

Changzhou, China

Tel : +86(0)51985150205

Fax : +86(0)51985150206

e-mail : aksa@aksachina.com

www.aksa.com.tr